

Storage Electric Water Heater HORIZONTAL SERIES

USER MANUAL

D30-15A6
D50-15A6
D80-15A6
D100-15A6

Warning notices: Before using this product, please read this manual carefully and keep it for future reference. The design and specifications are subject to change without prior notice for product improvement. Consult with your dealer or manufacturer for details.
The diagram above is just for reference. Please take the appearance of the actual product as the standard.

THANK YOU LETTER

Thank you for choosing Midea! Before using your new Midea product, please read this manual thoroughly to ensure that you know how to operate the features and functions that your new appliance offers in a safe way.

CONTENTS

THANK YOU LETTER	01
SAFETY INSTRUCTIONS	02
SPECIFICATIONS	04
PRODUCT OVERVIEW	05
QUICK START GUIDE	07
PRODUCT INSTALLATION	08
OPERATION INSTRUCTIONS	10
CLEANING AND MAINTENANCE	11
TROUBLESHOOTING	12
TRADEMARKS, COPYRIGHTS AND LEGAL STATEMENT	13
DISPOSAL AND RECYCLING	13
DATA PROTECTION NOTICE	14

SAFETY INSTRUCTIONS

Intended Use

The following safety guidelines are intended to prevent unforeseen risks or damage from unsafe or incorrect operation of the appliance. Please check the packaging and appliance on arrival to make sure everything is intact to ensure safe operation. If you find any damage, please contact the retailer or dealer. Please note modifications or alterations to the appliance are not allowed for your safety concern. Unintended use may cause hazards and loss of warranty claims.

Explanation of Symbols



Warning

The signal word indicates a hazard with a medium level of risk which, if not avoided, may result in death or serious injury.



Attention

The signal word indicates important information (e.g. damage to property), but not danger.



Caution

The signal word indicates a hazard with a low degree of risk which, if not avoided, may result in minor or moderate injury.

Read these operating instructions carefully and attentively before using/commissioning the unit and keep them in the immediate vicinity of the installation site or unit for later use!

⚠ CAUTION: Risk of injury!

Before installing this water heater, check and confirm that the earthing on the supply socket is reliably grounded. Otherwise, the electrical water heater can not be installed and used. Do not use extension boards. Incorrect installation and use of this electrical water heater may result in serious injuries and loss of property.

Special Cautions

- The supply socket must be earthed reliably. The rated current of the socket shall not be lower than 16A. The socket and plug shall be kept dry to prevent electrical leakage.
- The installation height of the supply socket shall not be lower than 1.8m.
- The wall in which the electrical water heater is installed shall be able to bear the load more than two times of the heater filled fully with water without distortion and cracks. Otherwise, other strengthening measures shall be adopted.
- The pressure relief valve attached with the heater must be installed at the cold water inlet of this heater(see Fig.1), and make sure it is not exposed in the foggy. The water may be outflowed from pressure relief valve, so the outflow pipe must open wide in the air; The pressure relief valve need to be checked and cleaned regularly, so as to make sure it will not be blocked.

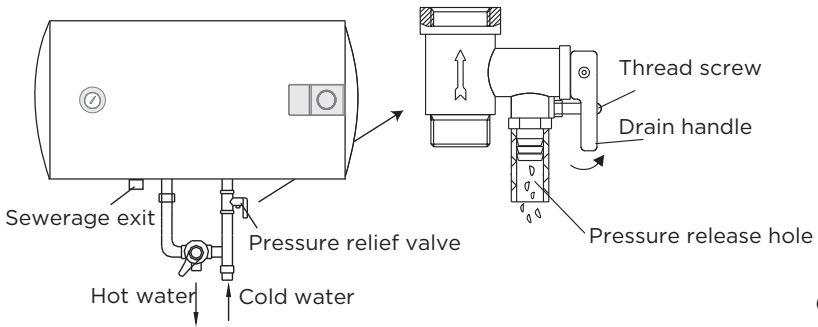

(Fig.1)

- When using the heater for the first time(or the first use after maintenance), the heater can not be switched on until it has been filled fully with water. When filling the water, at least one of the outlet valves at the outlet of the heater must be opened to exhaust the air. This valve can be closed after the heater has been filled fully with water.
- The water heater is not intended for use by persons(including children)with reduced physical, sensory or mental capabilities, or lack of experience and knowledge, unless they have been given supervision or instructions concerning use of the appliance by a person responsible for their safety. Children should be supervised to ensure that they do not play with the heater.
- During heating, there may be drops of water dripping from the pressure release hole of the pressure relief valve. This is a normal phenomenon. If there is a large amount of water leak, please contact customer care center for repair. This pressure release hole shall, under no circumstances, be blocked; otherwise, the heater may be damaged, even resulting in accidents.

- The drainage pipe connected to the pressure release hole must be kept sloping downwards.
- Since the water temperature inside the heater can reach up to 75 C , the hot water must not be exposed to human bodies when it is initially used. Adjust the water temperature to a suitable temperature to avoid scalding.
- If the flexible power supply cord is damaged, the special supply cord provided by the manufacturer must be selected, and replaced by the professional maintenance personnel.
- If any parts and components of this electrical water heater are damaged please contact customer care center for repair.
- This appliance is not intended for use by persons (including children) with reduced physical, sensory or mental capabilities, or lack of experience and knowledge, unless they have been given supervision or instruction concerning use of the appliance by a person responsible for their safety.
- Children should be supervised to ensure that they do not play with the appliance.
- The maximum inlet water pressure is 0.5MPa; the minimum inlet water pressure is 0.1MPa, if this is necessary for the correct operation of the appliance.
- The water may drip from the discharge pipe of the pressure-relief device and that this pipe must be left open to the atmosphere; The pressure-relief device is to be operated regularly to remove lime deposits and to verify that it is not blocked;
- In order to drain away the water inside the inner container, it can be drained away from the pressure release valve. Twist the thread screw of the pressure release valve off, and lift the drain handle upwards.(See Fig.1) A discharge pipe connected to the pressure-relief device is to be installed in a continuously downward direction and in a frost-free environment.

SPECIFICATIONS

Product Model	D30-15A6	D50-15A6	D80-15A6	D100-15A6
Volume(L)	27	47	74	93
Rated Power(W)	1500	1500	1500	1500
Rated Voltage(ACV)	220-240V~	220-240V~	220-240V~	220-240V~
Rated Pressure(MPa)	0.75	0.75	0.75	0.75
Max Of WaterTemperature(°C)	75	75	75	75
ProtectionClass	I	I	I	I
Water Proof Class	IPX4	IPX4	IPX4	IPX4

PRODUCT OVERVIEW

Product

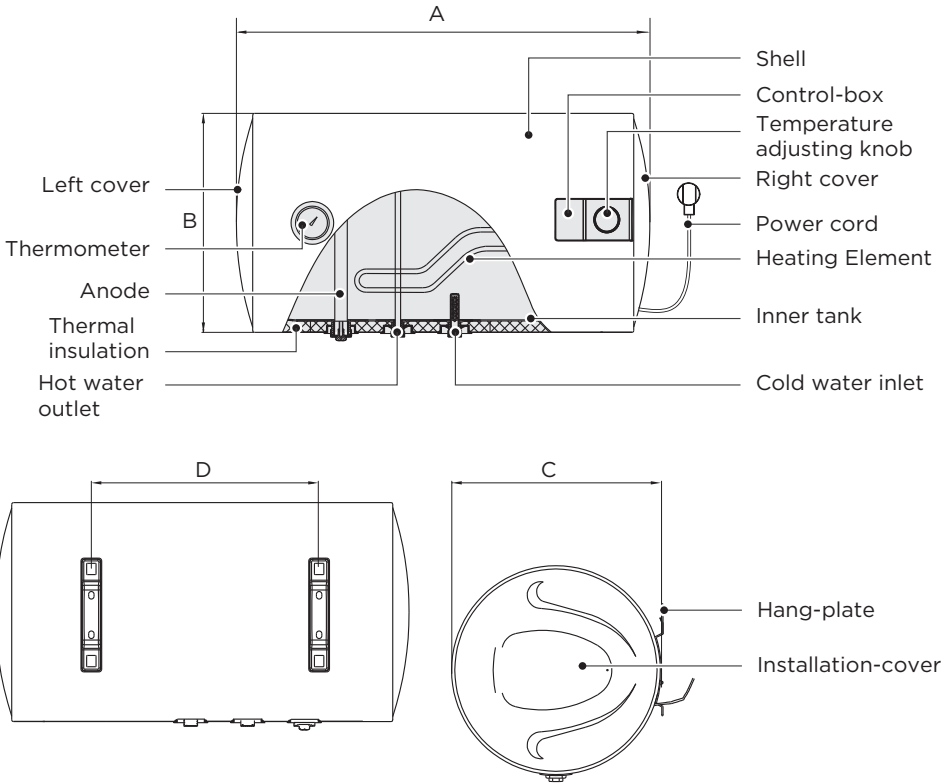

	D30-15A6	D50-15A6	D80-15A6	D100-15A6
A	518	675	775	920
B	385	385	450	450
C	385	385	450	450
D	160	310	297	447

(Note:All dimensions are in mm)

Internal Wire Diagram

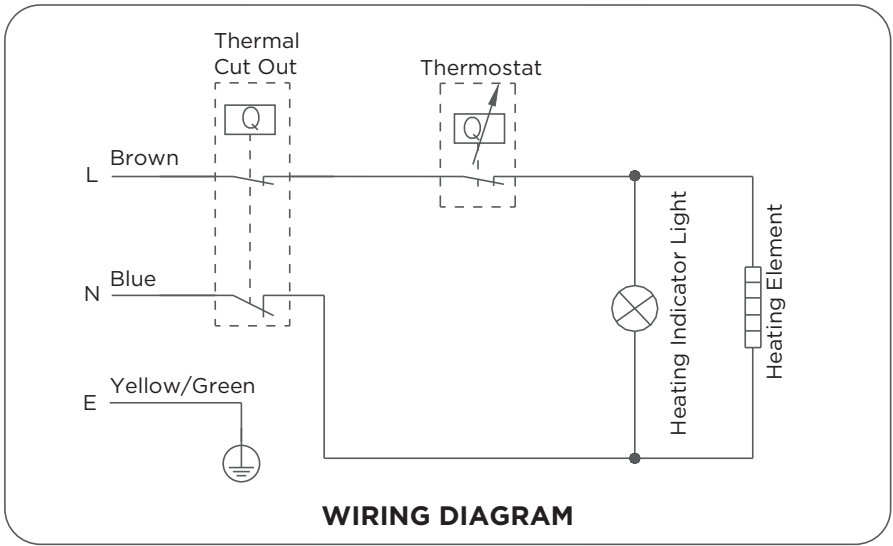

Accessories

Safety valve × 1

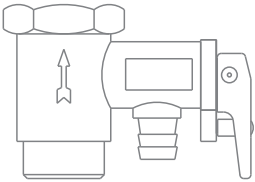

Wall hanging screw × 2



Plastic expansion pipe × 2

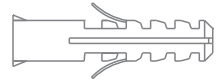

QUICK START GUIDE

Before First Use

CAUTION

Fill the inner tank with water before use.

1. Plug in

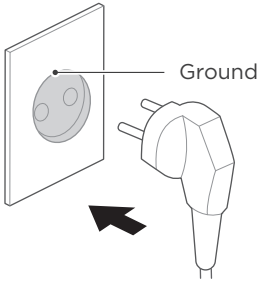

2. Rotate the thermostat knob clockwise to adjust the temperature inside the water heater.

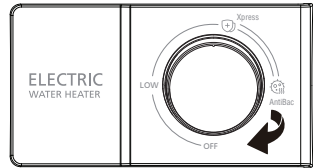

3. When the water temperature reaches the adjusted temperature, the heating will be stopped, and the heating indicator will be off. When the water temperature drops to a certain temperature, it will automatically resume heating.

4. Open the water outlet valve, you can use hot water.

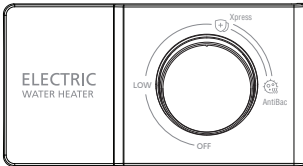

PRODUCT INSTALLATION

Installation Instruction

1. This electrical water heater shall be installed on a solid wall. If the strength of the wall cannot bear the load equal to two times of the total weight of the heater filled fully with water, it is then necessary to install a special support. In case of hollow bricks wall, ensure to fill it with cement concrete completely.
2. After selecting a proper location, determine the positions of the two install holes used for expansion bolts with hook (determined according to the specification of the product you select). Make two holes in the wall with the corresponding depth by using a chopping bit with the size matching the expansion bolts attached with the machine, insert the screws, make the hook upwards, tighten the nuts to fix firmly, and then hang the electric water heater on it (see Fig.2).

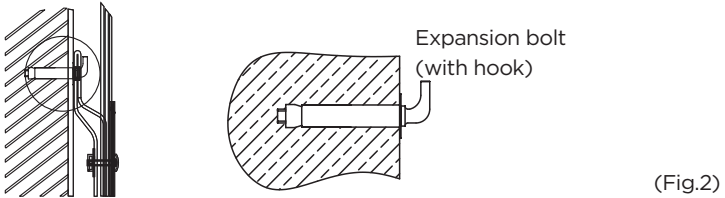

3. Install the supply socket in the wall. The requirements for the socket are as follows: 250V/10A, single phase, three electrodes. It is recommended to place the socket on the right above the heater. The height of the socket to the ground shall not be less than 1.8m (see Fig.3). If there is a fault on the power cable, it should be replaced by the manufacturer, agencies or qualified person who is able to do this so as to ensure the safety.

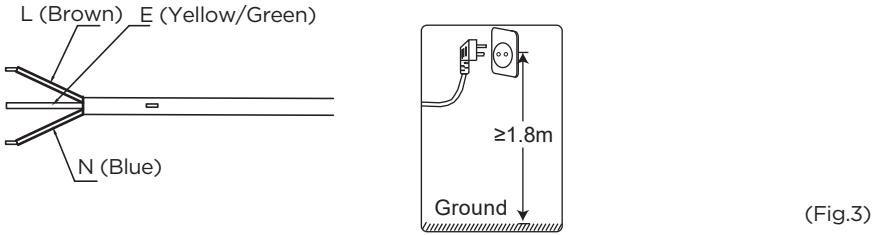

4. If the bathroom is too small, the heater can be installed at another place without sun-scorched and rain-drenched. However, in order to reduce the pipeline heat losses, the installation position of the heater shall be closed to the location shall be as near as possible to the heater.

Pipelines Connection

1. The dimension of each pipe part is G1/2" ; The massive pressure of inlet should use Pa as the unit; The minimum pressure of inlet should use Pa as the unit.
2. Connection of pressure relief valve with the heater on the inlet of the water heater.
3. In order to avoid leakage when connecting the pipelines, the rubber seal gaskets provided with the heater must be added at the end of the threads to ensure leak proof joints (see Fig.4).

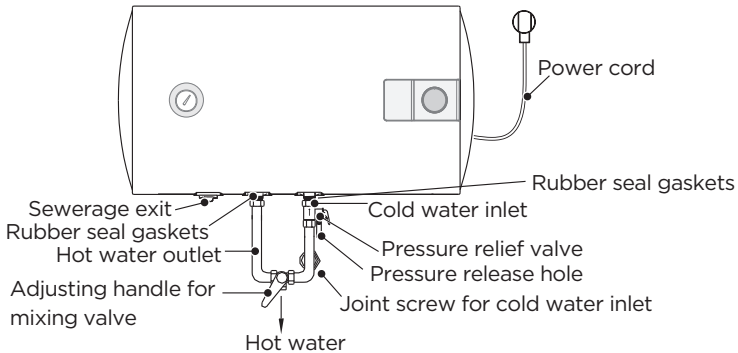

(Fig.4)

4. If the users want to realize a multi-way supply system, refer to the method shown in fig.5 for connection of the pipelines.

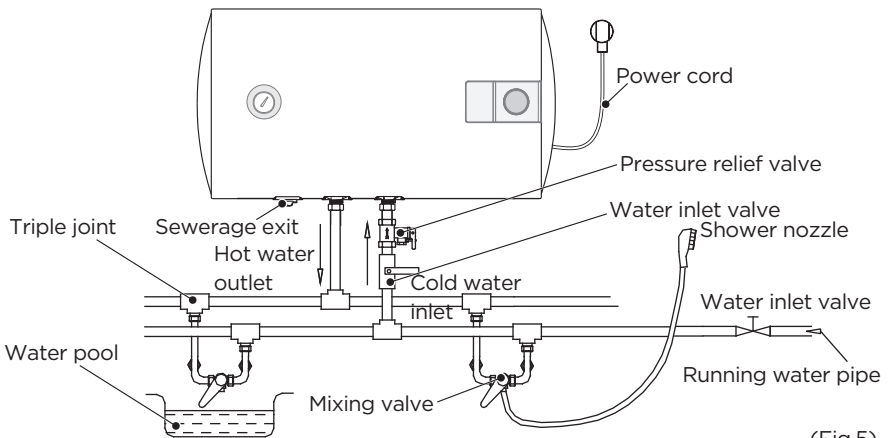

(Fig.5)

Note

Please be sure to use the accessories provided by our company to install this electric water heater. This electric water heater can not be hung on the support until it has been confirmed to be firm and reliable. Otherwise, the electric water heater may drop off from the wall, resulting in damage of the heater, even serious accidents of injury. When determining the locations of the bolt holes, it shall be ensured that there is a clearance not less than 0.2m on the right side of the electric heater, to convenient the maintenance of the heater, if necessary.

OPERATION INSTRUCTIONS

Methods of using

1. First, open any one of the outlet valves at the outlet of the water heater, then, open the inlet valve. The water heater gets filled with water. When water flows out of the outlet pipe it implies that the heater has been filled fully with water, and the outlet valve can be closed.

Note

During normal operation, the inlet valve shall be always kept open.

2. If the “Power” indicator lights up, the thermostat will automatically control the temperature. When the water temperature inside the heater has reached the set temperature, it will switch off automatically, when the water temperature falls below the set point the heater will be turned on automatically to restore the heating.

Operating Of The Unit

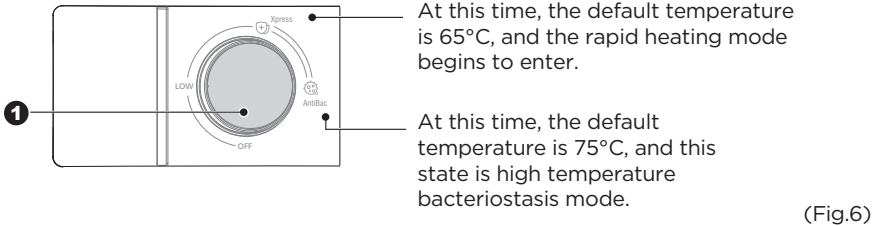

(Fig.6)

1. Rotate the knob according to the marking on the knob to increase or decrease the setting temperature.
2. In a power-on state, the machine is heating when the indicator light is blue. The indicator light goes out when the heating process is finished, in the insulating state.

CLEANING AND MAINTENANCE

Warning

Do not cut off power supply before maintenance, to avoid danger like electric shock.

1. Check the power plug and outlet as often as possible. Secure electrical contact and also proper grounding must be provided. The plug and outlet must not heat excessively.
2. If the heater is not used for a long time, especially in regions with low air temperature (below 0°C), it is necessary to drain water from the heater to prevent damage of the water heater, due to water freezing in the internal tank. (Refer Cautions in this manual for the method to drain away the water from the inner container).
3. To ensure long reliable water heater operation, it is recommended to regularly clean the internal tank and remove deposits on the electric heating element of the water heater, as well as check condition (fully decomposed or not) of the magnesium anode and, if necessary, replace it with a new one in case of full decomposition. Tank cleaning frequency depends on hardness of water located in this territory. Cleaning must be performed by special maintenance services. You can ask the seller for address of the nearest service center.
4. The water heater is equipped with a thermal switch, which cuts off power supply of the heating element upon water overheating or its absence in the water heater. If the water heater is connected to the mains, but water is not heated and the indicator doesn't light up, then the thermal switch was switched off or not switched on. To reset the water heater to the operating condition, it is necessary to:
 - (1). De-energize the water heater, remove the plate of the side/lower cover.
 - (2). Press the button, located at the center of the thermal switch, see Fig.7;
 - (3). If the button is not pressed and there is no clicking, then you should wait until the thermal switch cools down to the initial temperature.

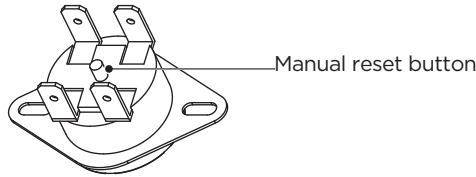

(Fig.7)

Warning

Non-professionals are not allowed to disassemble the thermal switch to reset. Please contact professionals to maintain. Otherwise our company will not take responsibility if any quality accident happens because of this.

TROUBLESHOOTING

Failures	Reasons	Treatment
The heating indicator light is off.	<ul style="list-style-type: none">Failures of the temperature controller.	Contact with the professional personnel for repair.
No water coming out of the hot water outlet.	<ul style="list-style-type: none">The running water supply is cut off.	Wait for restoration of running water supply.
	<ul style="list-style-type: none">The hydraulic pressure is too low.	Use the heater again when the hydraulic pressure is increased.
	<ul style="list-style-type: none">The inlet valve of running water is not open.	Open the inlet valve of running water.
The water temperature is too high.	<ul style="list-style-type: none">Failures of the temperature control system.	Contact with the professional personnel for repair.
Water leak.	<ul style="list-style-type: none">Seal problem of the joint of each pipe.	Seal up the joints.

Note

Parts illustrated in this use and care manual are indicative only, parts provided with the product may differ with illustrations. This product is intended for household use only. Specifications are subject to change without notice.

TRADEMARKS, COPYRIGHTS AND LEGAL STATEMENT

Midea logo, word marks, trade name, trade dress and all versions thereof are valuable assets of Midea Group and/or its affiliates (“Midea”), to which Midea owns trademarks, copyrights and other intellectual property rights, and all goodwill derived from using any part of an Midea trademark. Use of Midea trademark for commercial purposes without the prior written consent of Midea may constitute trademark infringement or unfair competition in violation of relevant laws.

This manual is created by Midea and Midea reserves all copyrights thereof. No entity or individual may use, duplicate, modify, distribute in whole or in part this manual, or bundle or sell with other products without the prior written consent of Midea.

All the described functions and instructions were up to date at the time of printing this manual. However, the actual product may vary due to improved functions and designs.

DISPOSAL AND RECYCLING

Important instructions for environment

Compliance with the WEEE Directive and Disposing of the Waster Product:
This product complies with EU WEEE Directive (2012/19/EU). This product bears a classification symbol for waster electrical and electronic equipment (WEEE).

This symbol indicates that this product shall not be disposed with other household wastes at the end of its service life. Used device must be returned to official collection point for recycling of electrical electronic devices. To find these collection systems please contact to your local authorities or retailer where the product was purchased. Each household performs important role in recovering and recycling of old appliance. Appropriate disposal of used appliance helps prevent potential negative consequences for the environment and human health.



Compliance with RoHS Directive

The product you have purchased complies with EU RoHS Directive (2011/65/EU). It does not contain harmful and prohibited materials specified in the Directive.

Package information

Packaging materials of the product are manufactured from recyclable materials in accordance with our National Environment Regulations. Do not dispose of the packaging materials together with the domestic or other wastes. Take them to the packaging material collection points designated by the local authorities.

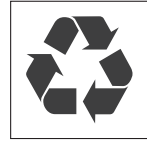

DATA PROTECTION NOTICE

For the provision of the services agreed with the customer, we agree to comply without restriction with all stipulations of applicable data protection law, in line with agreed countries within which services to the customer will be delivered, as well as, where applicable, the EU General Data Protection Regulation (GDPR).

Generally, our data processing is to fulfil our obligation under contract with you and for product safety reasons, to safeguard your rights in connection with warranty and product registration questions. In some cases, but only if appropriate data protection is ensured, personal data might be transferred to recipients located outside of the European Economic Area.

Further information are provided on request. You can contact our Data Protection Officer via **MideaDPO@midea.com**. To exercise your rights such as right to object your personal data being processed for direct marketing purposes, please contact us via **MideaDPO@midea.com**. To find further information, please follow the QR Code.



make yourself at home



www.midea.com

© Midea 2023 all rights reserved